

ALIVE AIR PURIFIER

State-of-the-Art 9-Stage Air Purification System



Owner's Manual

Please read and fully understand this manual before operating your Alive Air Purifier.

COMPLETE VIDEO INSTRUCTIONS ARE AVAILABLE AT:
www.aliveairpurifier.com/alive-air-video-help
www.aliveair.com • aliveair@mchsi.com • Ph: 800-215-1689

SAFETY OPERATION

Please exercise caution when using the Alive Air Purifier or any other electrical device! This manual describes the safety precautions that should be observed in relation to your air purifier. Please review carefully **BEFORE** using the product.

SPECIAL ATTENTION



RATED
VOLTAGE

The voltage rating for air purifiers sold in the USA, Japan and Canada is AC100-120V, 50/60Hz and in Europe is AC 230V, 50Hz. Using the wrong current may result in unit damage, electrical shock or fire.



DO NOT
DISMANTLE

Do NOT attempt to dismantle, repair or modify this device on your own. Doing so could result in electrical shock or damage to the unit. In the event of malfunction, contact an authorized maintenance facility.



AVOID HEAT
SOURCES

Do NOT operate your air purifier in places where flammable, explosive or otherwise combustible materials are stored.



AVOID
DIRECT
SUNLIGHT

Do NOT place the unit in direct sunlight or near lit fireplaces, furnaces, ovens or other high temperature objects. Doing so can damage the air purifier and may pose a fire hazard. Avoid operating the unit when the air temperature exceeds 104 F/40 C.



DO NOT
TAMPER

Do NOT place foreign objects in air purifier that can damage the unit or result in electrical shock. To avoid machine damage, injury and accidents, Do Not allow children to touch or play with this device.



DAMAGED
CORD

If the electric cord is damaged in any way, it must be replaced by the manufacturer or a qualified service center. NEVER operate a unit with a damaged electric cord. Doing so presents a serious risk of fire and/or electrical shock.



KEEP AWAY
FROM WATER

To prevent the possibility of electrical shock or short-circuiting your air purifier, Do NOT place the unit in or near the shower, bathtub or other places where water seep into and damage the unit.



DON'T
COVER

Do NOT operate your air purifier while it's covered with fabric, plastic or other materials. This can obstruct air flow, damage the unit and may pose a fire hazard.



AVOID
DISTORTION

To avoid distortion or interference, your air purifier should be placed at least three (3) feet from computers, televisions and radios.



WHEN TO
UNPLUG

For safety reason and to avoid the risk of electrical shock and/or fire, unplug your air purifier from the electrical outlet under each of the following conditions

- When cleaning or servicing the air purifier or replacing filters.
- When you will not be using your air purifier for an extended time period.
- When moving the unit from one location to another.

WARNING: The Alive Air Purifier is equipped with a polarized plug, that is one blade is wider than the other. The polarized plug is a safety device to reduce the risk of fire, shock and personal injury and is intended for use in a polarized outlet. The plug will fit only one way in a polarized outlet. Insert the wide blade of the plug into the wide slot of the outlet. If the plug does not fully fit into the outlet, reverse the plug. Never force the plug into any socket or try to defeat this important safety feature in any way. If it still does not fit contact a qualified electrician. Do not remove, replace, repair or in any way tamper with the original plug supplied with this unit.

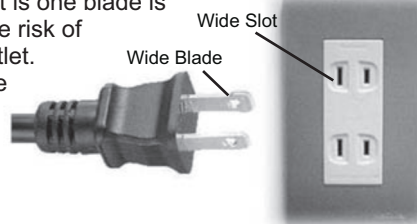

CONTROLS & AIR FLOW VENTS

Front Face Plate

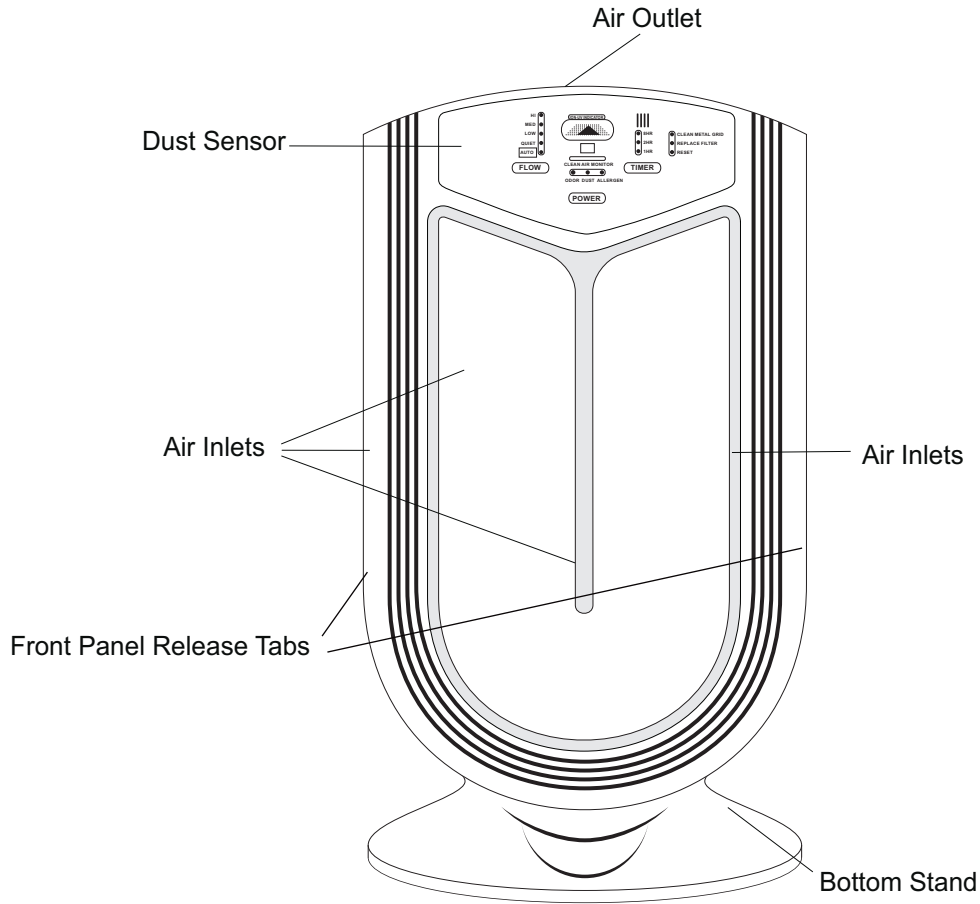

Soft Touch Control Panel

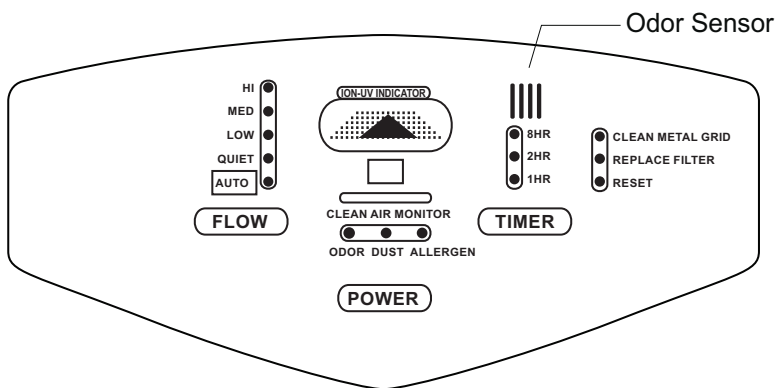

Remote Control

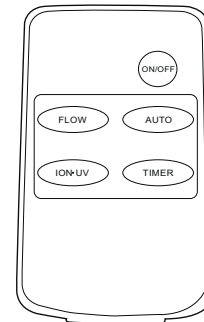

MAJOR COMPONENTS

Back View

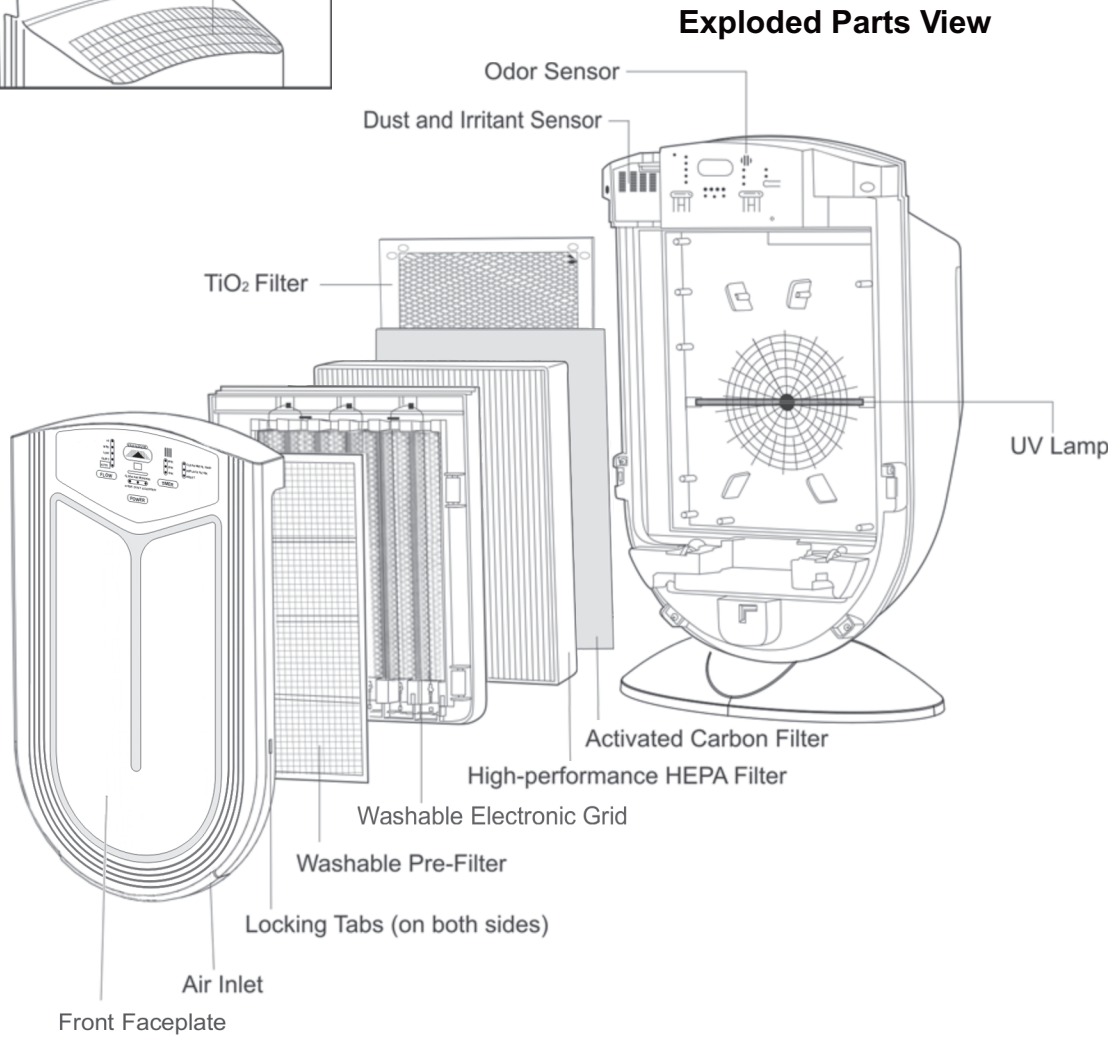

ABOUT YOUR NEW ALIVE AIR PURIFIER

The Alive Air Purifier features a State-of-the-Art 9-Stage Air Pollution Detection, Diagnostic, Filtration and Purification System that includes sophisticated air quality sensors; diagnostic sensors; a Washable Pre-Filter for trapping larger airborne particulates like hair and dust; a Washable Electrostatic Grid designed with a negative charge for attracting soot pollution and dust; a Hi-performance True HEPA Filter that is 99.97% effective in capturing dust, pollen, mold spores, pet dander, mites - harmful airborne particles as small as 0.3 microns; an Activated Carbon Filter attached which absorbs noxious odors, fumes, gases and smoke; Dual Photo Catalyst Nanotechnology - TiO₂ Germicidal Sanitizer that suppresses the growth of harmful micro-organisms including mold and mildew. When the UV light hits the TiO₂ filter, its effectiveness is magnified by 40X; a Germicidal UV Light which actually destroys bacteria, viruses and other airborne germs; and a Negative Ion Generator that is extremely effective at clearing smoke and pollution, decreasing carbon monoxide levels, combating airborne infections and even reducing fatigue. It creates 'Healthy Air' and positively affects brain chemistry.

The Alive Air Purifier also features a powerful but ultra quiet 5-speed fan; intuitive easy to read LCD control panel; and a 4 mode automatic on/off timer function, though the machine is made to run continuously 24/7, spring, summer, winter, fall windows open/windows closed. The Alive Air Purifier's use of 9 separate, integrated air filtration and purification technologies allows the unit to match and surpass the best aspects of competing air purifiers while avoiding their multiple shortcomings. Instead of just offering a handful of features that eliminate SOME air pollutants, SOME odors or a FEW germs, this unit integrates a complex set of technologies which detect and eliminate harmful air pollutants, dangerous germs and noxious odors that other limited-technology air purifiers simply can't. ***That's the Alive Air Purifier difference!***

EXPLANATION OF INDICATORS

Negative Ion Indicator

During the process when negative ions are generated, the blue indicator on the Soft Touch Control Panel will gradually change from bright to dim and from dim back to bright every 5 seconds.

Odor Indicator

The odor indicator on the Soft Touch Control Panel will glow whenever the odor sensor detects odor (such as indoor smoke).

Dust & Irritant Indicator

The dust-and-irritant indicator on the Soft Touch Control Panel will glow whenever dust or other irritants are detected.

Clean Air Monitor

When odor, dust or irritants are detected, the Clean Air Monitor function will indicate the level of pollution on the Soft Touch Control Panel. When pollution is severe, all the LED's will glow.

BEFORE USE

IMPORTANT - Do NOT Use with Commercial Air Fresheners:

DO NOT use plug-ins such as Glad or Airwick Plug-ins, Oust, Febreze or scented candles. Chemicals in these products interfere with the unit's sensors and clog the HEPA filter, rendering it useless within an hour and may also contribute to asthma and allergies.

- **ONLY IF POSSIBLE** (not required unless you've been using any commercial air freshener related products mentioned above), open a window, ventilate the room for an hour, then close the window.

PLACING YOUR AIR PURIFIER

Place your air purifier against a wall, near an electric outlet with at least 12 inches clearance on the back, front and sides. It is also best to place it away from other electronic devices, such as your TV, and where it will be out of any children's play area. **DO NOT** place it near a wood stove or fire place.

BASIC OPERATION - Manually Operating Your Air Purifier

IMPORTANT: In order to prevent possible damage to the circuit board during power surges or electrical storms, **Plug your air purifier into a SURGE PROTECTOR** (as you would with a computer or TV) **BEFORE plugging the unit directly into a standard 120V/60Hz electrical outlet.**

- Press the POWER ON/OFF button on the air purifier to turn it on. The unit will start operating automatically and the negative-ion UV indicator will automatically turn on.
- At this point, you can press the FLOW button to run the purifier on HIGH, MEDIUM, LOW, or QUIET without additional set-up. The fan setting will change according to the number of times you press the button.
- We recommend you run your air purifier continuously 24/7 on either HIGH or MEDIUM summer, winter, spring, fall, windows open/windows closed. Your unit uses so little electricity, the effective on your electrical bill will be negligible. No additional setup is required; you can simply begin using your air purifier.

TIMER OPERATION

In addition to its other operational modes, your new air purifier features a TIMER function offering a.) 1 hour continuous on then automatic turn-off; b.) 2 hours continuous on then automatic turn-off and c.) 8 hours continuous on then automatic turn-off. To operate the timer function:

- Press TIMER button to set operation timing.
- Under the TIMER function, the operation timing will be set according to the number of times you press the TIMER button. The LED will show 1 Hour, 2 Hour, 8 Hour.

AUTOMATIC OPERATION - Setting & Using "Auto" Mode

Your advanced technology air purifier is equipped with a sophisticated air quality sensor capable of detecting elevated levels of odor, dust, or irritants in the air. When set to "AUTO" using the unit's Flow button, the air purifier automatically adjusts its operational mode (switching between LOW and MED) according to the indoor air pollution levels detected by the sensor. **HOWEVER**, to use the unit's AUTO function you **MUST** first program a 'clean air reference' using the procedures described below **BEFORE** setting the unit's AUTO function.

Programming A Clean Air Reference

IMPORTANT: DO NOT attempt to use the Auto Setting if you have any unusual air quality conditions such as mold, mildew, tobacco smoke, a wood-burning fireplace, pets, freshly painted walls, new flooring or new carpeting that is still 'out gassing' chemical fumes, etc. Such conditions will not allow the air purifier's sensor to accurately establish a "clean air reference" on which to base the Auto Setting. If these conditions exist, simply set the unit to MEDIUM or HIGH and operate manually without any further set up as described above in the section entitled BASIC OPERATION - Manually Operating Your Air Purifier.

1. Turn on your air purifier and IMMEDIATELY push the FLOW button to set the unit on HIGH and let it run continuously for 3 hrs with the UV light ON to purify the air in the room.
2. Leaving the machine with power set to ON, UNPLUG it from the wall for 10 seconds.
3. PLUG it back in. The odor indicator light will blink as it samples and memorizes the existing purified air condition. After two minutes, the indicator light will stop blinking to indicate the end of memorization. *(The existing indoor air quality will then serve as the baseline definition for 'Clean Air').*
4. Push the FLOW button to set the unit on AUTO and leave it on that setting. 'SET IT AND FORGET IT'.
5. Using the established 'clean air reference,' the air quality sensor will then detect changes in air quality that exceed the reference point and adjust the unit's settings accordingly. Of course, you can always put it on the other speed settings, such as QUIET for sleeping or on HIGH if you are, for example, expecting company and want the air to be cleaned faster.

■ **PLEASE NOTE:** After you have a 'clean air reference' for the AUTO SENSOR, your air purifier is made to run 24/7, summer, winter, spring, fall, windows open/windows closed. However, whenever you do unplug the air purifier, have a power outage, turn off the unit for some other reason, or remove the face-plate to clean the pre-filters, the memory of the 'clean air reference' will be erased and you will need to repeat these procedures to establish a new 'clean air reference.'

- Sometimes the sensor is not as sensitive when first purchased or after being unplugged for over a week. Its sensitivity will begin to increase after one to two days of operation.
- Please watch our 7 'Video Instructions' on all aspects of using and setting up the Alive Air Purifier. www.aliveairpurifier.com/alive-air-video-help.
- Any questions, feel free to call **1-800-215-1689** and we'd be glad to help.

CLEANING AND MAINTENANCE

IMPORTANT ***DO NOT** use pressurized air or a vacuum cleaner on any part of the air purifier!*

Regular Cleaning and Maintenance

Dust sensor cover — and — **Dust sensor[†]**

- Use a non-scented 'Swifter' refill cloth to wipe dust off the sensor or a slightly moistened cloth if no Swifter cloth is available.

TiO₂ Filter

- Requires no maintenance.

HEPA Filter

Note: If the HEPA filter in comparison with a white piece of paper shows any greyish or brownish areas, email us at AliveAir.com@mchsi.com or call (800) 215-1689 for a replacement filter.

Washable Electronic Grid Filter

and

Washable Pre-Filter[‡]

- See cleaning instructions for the Washable Pre-Filter & Electronic Grid on Page 10

Front Face Plate

- See cleaning instructions for the Washable Pre-Filter & Electronic Grid on Page 10

UV Lamp

- UV Lamp needs no monthly maintenance but should be replaced every 12 months.

For Instructions regarding the disassembly of the face plate and filters refer to page 8.

[†]If the unit is in a high dust area, or if you ever find that the Allergen Light stays on continuously, though you've cleaned the pre-filter and electronic grid, take apart and clean the dust sensor located behind the Dust Sensor Cover. This maintenance should be done once or twice a year, depending on air quality conditions. See 'CLEANING THE DUST SENSOR' on page 12 or Video #6 www.aliveairpurifier.com/alive-air-video-help before attempting this.

[‡]Refer to Video Instructions - #2 Cleaning the Alive Air Purifier Washable Filters www.aliveairpurifier.com/alive-air-video-help

CLEANING AND MAINTENANCE (Cont.)

IMPORTANT: These disassembly instructions are provided as a general guide. You **Do NOT** need to fully disassemble the unit to clean an individual component or filter.

- Before starting any cleaning or maintenance, always turn-off and unplug the unit.

Disassembling the Alive Air

- After unplugging, either leave the unit upright or carefully lay it down face-up. Disassemble the unit in sequence of 1 to 5 as shown below. (Put the unit back together in the reverse 5 to 1 sequence.)

1. Remove the Front Face Plate

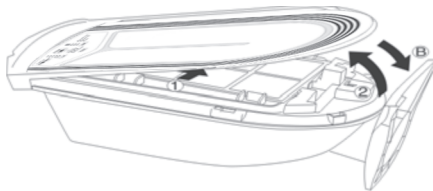

- ① Press the locking tabs on both sides of the device
- ② Gently lift up the front cover at a 45° angle as shown

When assembling

- ③ Firmly reconnect the front cover back to its original position
 - ④ Make sure the two locking tabs reattached immovably
- ⚠ Please attach firmly at the connecting locations



2. Remove Washable Black Mesh Pre-Filter

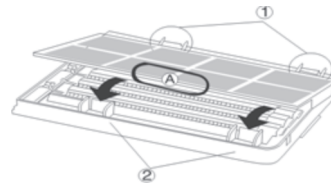

- ③ Hold position A and lift up the front filter

When assembling

- ① Attach the filter to the connecting locations on the side
- ② Fasten the filter on the front connecting locations

3. Remove the Washable Electronic Grid

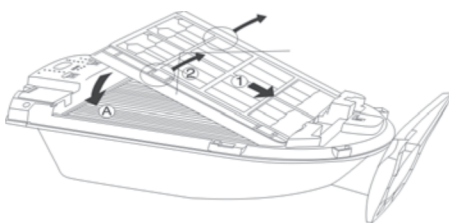

- ① Push the electronic grid towards the bottom of the device
- ② Hold the two tabs and lift up the electronic grid

When assembling

- ① Push the electronic grid towards the bottom of the device
- ② Insert into position A

4. Remove the HEPA/Activated Charcoal Filter

Do not reverse the front and back of the filter

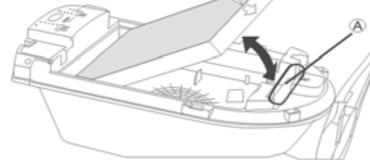

- ④ Place your hand in position A and pull out the filter. When replacing the Filter, please reinsert in the exact front-and-back direction indicated by the arrows on the side. **The white HEPA Filter should face you and the black Activated Carbon Filter should face the unit.**

5. Remove the TiO2 Filter

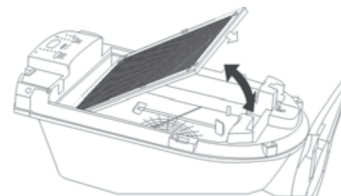

- ④ Hold the clips of both sides to help pulling out the filter.

CLEANING AND MAINTENANCE (Cont.)

Cleaning and Maintenance of Washable Pre-Filter & Electronic Grid

CLEAN THE PRE-FILTER & ELECTRONIC GRID ONCE A MONTH and/or, if any of the following occurs, clean immediately or repeat cleaning...

1. If the electronic grid is making electrical discharge sounds.
2. If the purifier has been used frequently in an area with poor air quality conditions.

Clean Metal Grid or Replace Filter Red Light Continually Flashing: The 'Clean Metal Grid' indicator operates on a preset timer. So, if the indicator is flashing and you're certain you've been cleaning the pre-filter and electronic grid monthly, **You May NOT Need To Re-Clean The Unit.** Simply reset the timer as instructed on page 11. If you've forgotten to clean these two filters in the prior month, clean them as instructed in this section and then reset the 'Clean Metal Grid' indicator.

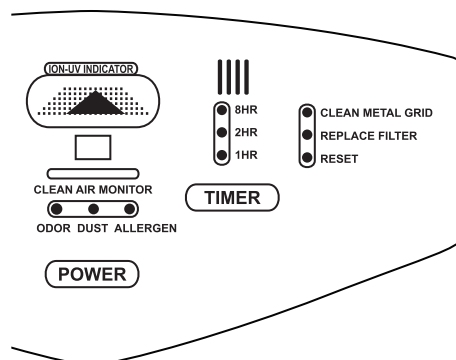

Cleaning Instructions

1. Remove the Front Face Plate.
2. Remove the Washable Pre-Filter.

Please refer to page 8 for detailed instructions on the removal of the Front Face Plate, Washable Pre-Filter and the Washable Electronic Grid Filter.

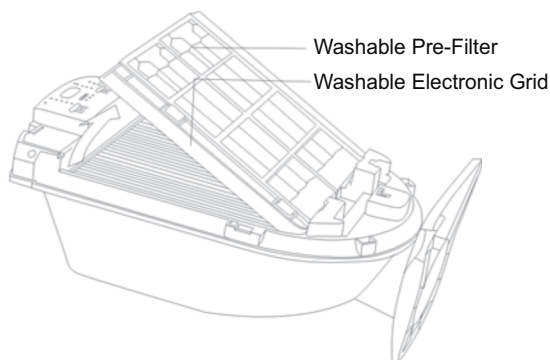

3. Remove the Washable Electronic Grid.

Note: Please wear protective gloves to avoid cutting or scratching your hands.

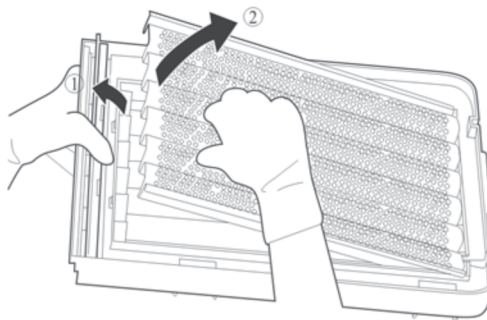

CLEANING AND MAINTENANCE (Cont.)

Cleaning and Maintenance of Washable Pre-Filter & Electronic Grid (Cont.)

4. Cleaning the Washable Pre-Filter & Electronic Grid

- Put a very small amount of Dish Detergent such as Dawn [**NOT automatic dishwasher detergent**] in the bathtub.
- Please do not clean using acidic or alkaline detergent that can create rust on the surface of device.
- Place the two washable filters in the bathtub
- Fill the tub with warm water (not hot) to just cover the filters
- Soak (**Do NOT Scrub**) the two filters for a good half hour to remove dust and grime
- Drain the tub and rinse the filters under the shower head. Though the faceplate does not need soaking, rinse both sides with the shower head as well.
- Please take care not to damage any wiring while cleaning the electronic grid. If any electrical discharge wire is broken, the device will lose part or all of its dust collecting capability.
- Any broken wires should be thrown away instead of being left inside the unit. Otherwise, a dangerous short-circuit or high-voltage sparks may occur.
- Please contact AliveAir@mchsi.com for additional electrical discharge wire.

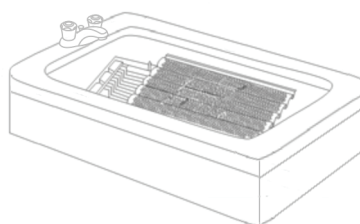

5. Air Dry ONLY all washed parts.

- Air dry the pre-filter, electronic grid and faceplate overnight. Operating a wet unit may cause electrical shock or malfunction.
- If the front cover of the electronic grid is not properly installed, the unit will not function.
- Please make sure the plastic wrap for the electrical discharge wire is located in its proper position.

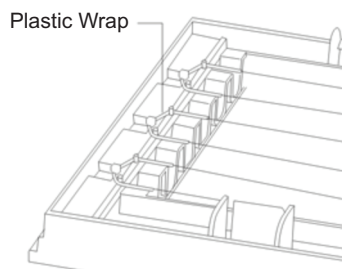

6. ONLY if using AUTO SETTING, a New 'Clean Air Reference' is required after cleaning

- Every time you remove the faceplate to clean the unit, if there is a power outage, or you power it off, or if you unplug the unit for any reason, you will have to re-program a 'reference for clean air' if you are leaving your machine on AUTO.
- This is the case because any memorized content will have been completely erased. See page 6 for instructions on resetting the auto-sensor.

Electronic Grid Wire Replacement

- It's unusual to break a grid wire if properly following the above instructions for cleaning the Electronic Grid. But, if it does happen, call (800) 215-1689 to order a replacement wire(s). **Do NOT** operate your air purifier until you've received and replaced the broken wire(s).

~ **CAUTION: The grid wire and spring ends may have sharp edges. Please, handle them with care.** ~

- The Electronic Grid should have 3 wires extending from a bottom 'hook', around the top and back down to another 'hook'. Place one spring end on a bottom hook.
- Wrap the wire with it's plastic coated center around the 3 pegs near the top of the grid assembly. Gently stretch the wire just enough to place the spring end over the hook at the lower end of the grid assembly.
- For additional visual instructions, see "Plasma Grid Wire Replacement" illustration at <http://aliveairpurifier.com/wp-content/uploads/2009/09/plasma-wire1.jpg>

CLEANING AND MAINTENANCE (Cont.)

Replacing HEPA Filter

- Change HEPA filter every 6-8 months by comparing a white piece of paper to the filter. If filter looks a slight bit brownish or greyish, change it. Change more often if cigarette smoke is present. See page 7 for HEPA filter removal and installation procedures.

Note: The 'Replace Filter' indicator operates on a preset timer. So, if the indicator is flashing and an inspection of the HEPA filter, compared to a white sheet of paper, confirms it's NOT brownish or greyish, you can simply reset the timer as instructed below. If the HEPA filter DOES appear brownish or greyish, remove and replace the filter as instructed on page 7 and then reset the 'Replace Filter' indicator.

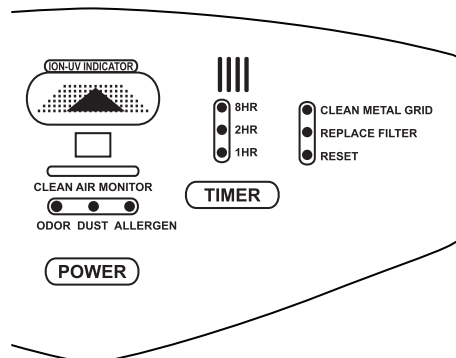

Replacing UV Lamp

The UV bulb lasts about 5,000 hours. Replace it when a.) it is damaged; b.) when no blue light is observed at night, when standing behind the unit, looking down through the vents on top of the unit; **OR** c.) **at least every 12 months.**

- Remove the Face Plate, Pre-Filter, Electronic Grid, HEPA/Charcoal filter and TiO2 filter as shown on page 7.
- The bulb has two wing-like protrusions at the end of the black area on each side that fit into left and right UV slots on the unit. **Without touching the actual glass bulb**, grab the black section of the bulb that's inserted on the left UV slot and push it towards the right spring loaded UV slot. To successfully unlock the bulb, you may have to turn it 1/4 of the way towards you. While still pushing the bulb to the right, pull the bulb towards you and it should release from both slots.
- Reverse the above process when installing the new bulb. Hold the wing-like protrusions on each side of the new bulb in the 12:00 and 6:00 positions to align with the unit's UV slots. Insert the bulb into the right hand spring loaded side first, then the left hand side and turn the bulb 1/4 turn towards the machine locking the bulb in position.
- For additional visual instructions, see the Video Instruction called: "Changing the UV Bulb" at <http://aliveairpurifier.com/alive-air-video-help/>

Resetting the CLEAN METAL GRID and REPLACE FILTER Indicators

IMPORTANT: Both these indicators are pre-set at the factory to light up after approximately 6 months. Neither indicator is directly tied to whether filters are in need of cleaning or if the HEPA/Charcoal Filter needs replacing. If you've already cleaned the metal grid once a month and properly maintained and replaced the HEPA/Charcoal filter as outlined in this manual, then when either of these lights come on, simply reset them as indicated below.

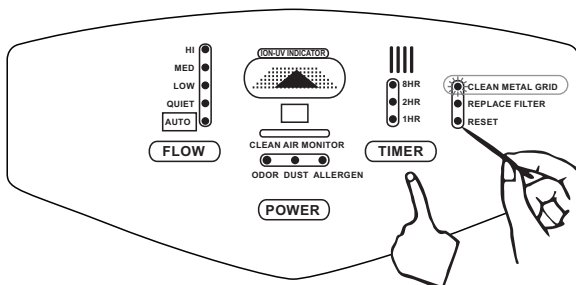

1. Resetting CLEAN METAL GRID Indicator

When the unit is **plugged in, but turned off**, reset the CLEAN METAL GRID indicator by pushing a straightened paper clip into the RESET hole while pushing the TIMER button at the same

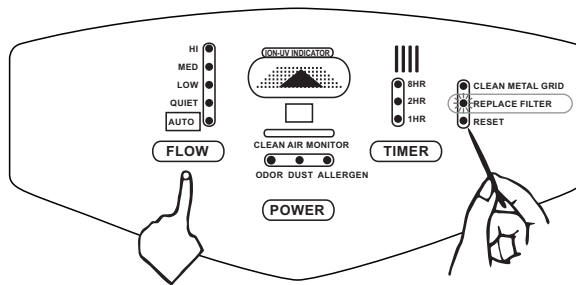

2. Resetting REPLACE FILTER Indicator

When the unit is **plugged in, but turned off**, reset the REPLACE FILTER indicator by pushing a straightened paper clip into the RESET hole while pushing the FLOW button at the same

CLEANING AND MAINTENANCE (Cont.)

Cleaning the Sensors

You **ONLY** need to clean the Sensor Lens if the Allergen Light Stays ON continuously even after you've properly cleaned and maintained the unit. Sensor cleaning is usually required no more than once a year and only if you have extremely dusty air quality.

- **You'll Need:** small Phillips jeweler's screw driver, glass cleaner, Q-Tip, lint-free, microfiber or unscented Swifter type cloth.
- **AFTER Unplugging the unit,** remove the air purifier cover. You'll see a small grey faceplate on the upper left front of the unit. Push down the tab and remove the plate. Inside, you'll see a small silver covered sensor box with a white ribbon cable running from it. If there is not enough room to work with the sensor, gently pull the white cable another 1 or 2 inches from the hole it comes out of to give yourself some extra slack.
- Before taking apart the sensor, use the cloth to completely wipe clean the chamber which houses the sensor and the faceplate inside and out to prevent residual dust from falling back into the chamber after you finish cleaning the sensor.
- **Without disconnecting the white cable,** use your jeweler's Phillips screwdriver to unscrew the two small screws on the top of the silver sensor cover and remove it. **Do NOT** use a larger screw driver as you may strip the screws.
- Under the silver sensor cover you'll see a small circuit board on the back of which are two mounted sensor lenses. **Lightly** dampen one end of a Q-tip with glass cleaner and use it to gently clean both sides of the two lenses. Then dry both sides with the undampened end of the Q-tip. **Do NOT** use alcohol to clean the lenses as it may damage them.
- To reassemble the sensor, simply reverse the process by a.) placing the circuit board back in its housing; b.) screwing the silver cover back on; c.) reseating the sensor in the sensor chamber; d.) reinserting the two tabs at the bottom of the faceplate into their slots and snapping it back into place; and e.) replacing the air purifier cover.
- At this point you can resume using your air purifier normally. **HOWEVER, IF you intend to use the AUTO setting,** you will need to reestablish a 'clean air reference' using the procedures described on page 6 of this manual.

FREQUENTLY ASKED QUESTIONS

Clean Air Monitor

Why is there only one LED glowing all the time with the Clean Air Monitor function?

- Indoor air has been clean the whole time.
- The dust and irritant sensor could be too far away from any irritant for it to detect. Please move the unit closer to your major sources of pollution.

Why does the Clean Air Monitor indicator always have two LED glowing?

- Possibly because the room is not really a closed environment and pollution keeps coming in from the outside. Or, because there has been pollution created indoors (e.g. smoking/pet boxes etc.) the whole time. It will take some time for the Alive Air Purifier to achieve a clean environment under these conditions.

Why does the Clean Air Monitor function keep switching back and forth frequently?

- Sometimes the dust and irritant sensor is affected by cell phone or other wireless equipment. When using cell phone or other wireless equipment, please stay away from the unit.

Dust and Irritant Sensor

Why does the Dust and Irritant Sensor keep blinking?

- In some locations the top of the sensor will accumulate more dust than in others. Locations, This will decrease the efficiency of the sensor. (Please refer to the section above on the cleaning of the sensor.)

FREQUENTLY ASKED QUESTIONS (Cont.)

Odor Sensor

Why doesn't the Odor Sensor work?

- In the initial set-up of the unit, the Odor Sensor wasn't properly trained, you unplugged the air purifier, had a power outage, turned off the unit for some other reason, or removed the face-plate to clean the pre-filters. Please reestablish a 'Clean Air Reference' following the instructions provided on page 6 of this manual.
- When first purchased or when the unit has been unplugged for more than a week, the sensor will not be as sensitive. After 1 to 2 days of operation, the sensor will regain its sensitivity.

Filter

Why is it so hard for the filter to get rid of dust and odors?

- Have the front and back of the HEPA/Charcoal filter been mistakenly reversed?
- The HEPA/Charcoal filter has been saturated with a serious amount of dust (causing it to appear dark grey in color) or Febreze, Oust, smelly candles or Plug Ins have been used and it has saturated the charcoal filter. Please replace filter.

Electronic Grid

Why is it so difficult to eliminate dust and odor?

- If the electrical discharge wires or the electronic grid get too dirty. Please refer to page 9 on how to clean and maintain.
- If an electrical discharge wire been disconnected or broken? Contact aliveair@mchsi.com or call (800) 215-1689 for additional information and parts.

Cannot Turn On the Unit

Why is the unit not working even after turning it on?

- Has the plug been loosened or disconnected from the socket? Please check that the plug is properly plugged in to an outlet.
- Has something in the unit come loose in shipping or has it been properly reassembled after being cleaned? Please check for either of these conditions. The unit will not operate if the Washable Electronic Grid or the Front Face Plate has not properly been installed.

APPLICABLE AREAS

The unit is designed for any indoor room or living space up to 80 square meters or over 861 square feet. It can be used in living or family rooms, bedrooms, offices, studios, waiting rooms, hotels, hospitals, etc. If the unit is to be used in a smaller room, you may prefer to have the power setting on medium or low. Despite what you may believe or have been told, air does not easily move through doorways. As a result, you might either need multiple units if you want to clean adjoining rooms or you would have to move the purifier to the other areas to be cleaned.

TECHNICAL SPECIFICATIONS

Product Style: Alive Air	Dust Removal Rate: 1 micron 99.97% • 0.3 micron 80%
Rated Voltage: AC 120V/60Hz	Noise Level (dB): Quiet 20 • Low 35 • Med 45 • High 52
Power Consumption: 80W on HIGH	Air Volume (High): 3 m ³ /min. • 106 ft ³ /min.
Ion Output: $\geq 2 \times 10^6/\text{cm}^3$	Dimensions: 13.5" x 10" x 25.6" • 343 x 255 x 610 mm
Activated Oxygen Output: ≤ 0.05 ppm	Weight: 15.1 lbs • 6850 g
UV Spectrum: $\geq 20\mu$ w/cm ² at 10 cm distance.	Applicable Area: 80 m ² equivalent to 861 ft ²

PRODUCT SERVICING

In case of any malfunction, please contact Alive Air at **(800) 215-1689** or email: aliveair@mchsi.com

PRODUCT WARRANTY

- Alive Air warrants the Alive Air Purifier to be free from manufacturing and material defects for the following limited warranty periods from the original date of purchase.
 - 5 years for all plastic covers and casings (impacts or abuse are not covered).
 - 5 years on motor, fan blades, electric A/C cord.
 - 3 years on wiring and function buttons and switches.
 - 1 year on circuit board, sensors, remote, & internal electrical components including plasma filter.
- HEPA filter, UV light and batteries area is excluded from this warranty and should be replaced in accordance with the schedule set forth in the owner's manual or based on the consumer's own unique environmental air quality conditions.
- Our repair and replacement center will ONLY cover the cost of ground shipping for returning a repaired or replaced unit or parts to the original consumer purchaser. We do NOT pay for the consumer's shipping cost to return the product or part to an authorized service center
- This warranty shall not apply to damage caused through misuse, excessive wear and tear, neglect, unauthorized repair, to damage caused through installation, adaptation, modification or use in an improper manner or inconsistent with Alive Air's operating and maintenance instructions or to units operated outside the United States or Canada.
- Except in the case of fully warranted factory refurbished air purifiers, this warranty is valid only to the original owner with proof of purchase.
- Except by prior special arrangements with Alive Air, for purposes of this warranty, we do not cover the cost of return shipping outside the contiguous United States.

ALIVE AIR PURIFIER

State-of-the-Art 9-Stage Air Purification System

Marketing and distribution by:

ALIVE AIR MARKETING GROUP

Alive Air Marketing Group • Excelsior, Minnesota 55331

Customer Service Phone: 800-215-1689

www.aliveair.com • aliveair@mchsi.com

Replacement filters can be ordered at www.AliveAir.com

(Scroll down to just below the large blue specification box on our web page.)

© Copyright 2013. Alive Air Marketing Group. All Rights Reserved
Manufactured in China